

Color Variation

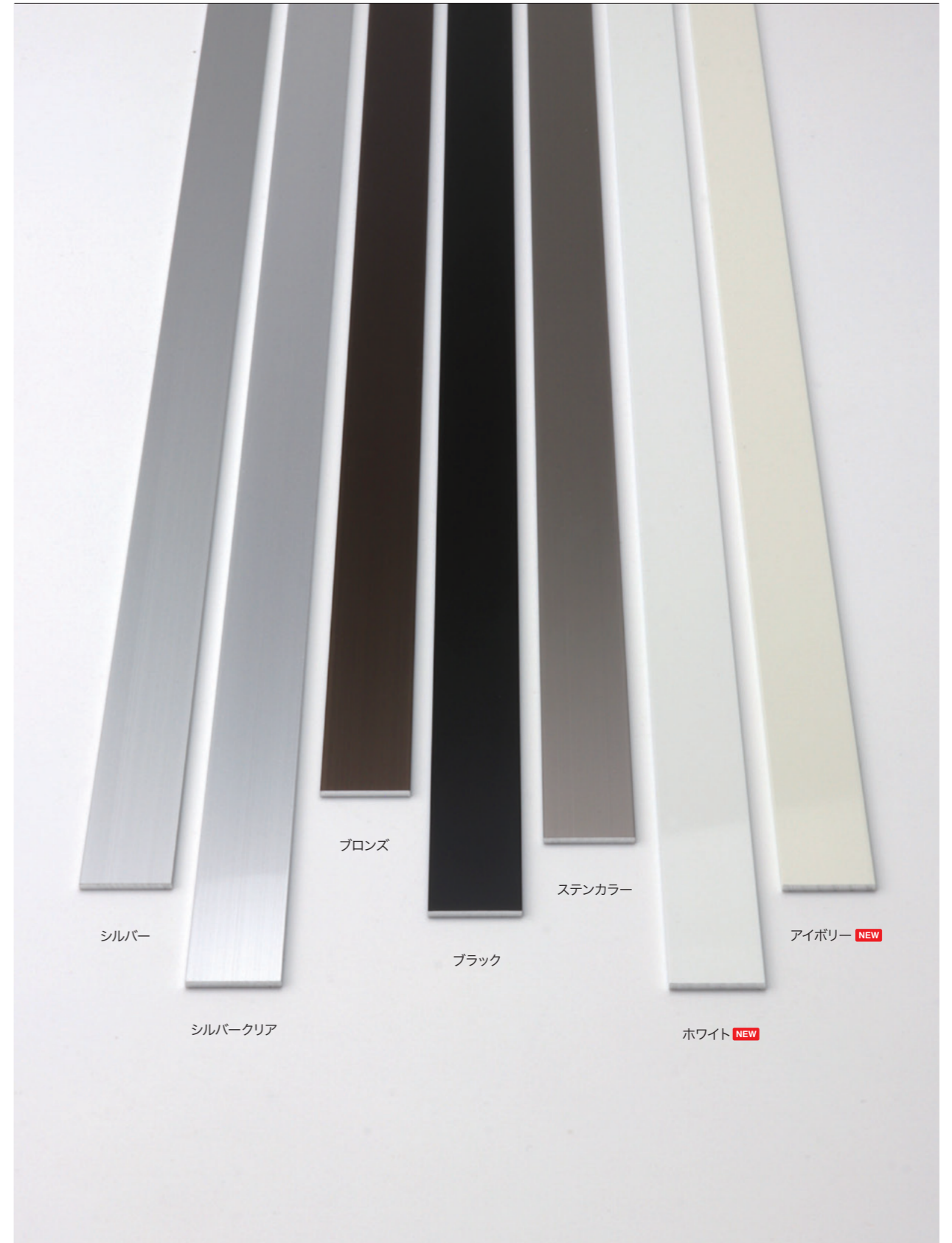

※印刷の都合上、実際の色と異なる場合があります

アルミアングル・角パイプ

A6063S-T5 オプション ▶ ■ロット販売(当社オリジナル抗菌アルマイト仕様・別注カラー) ■切断 ■穴明 ■塗装 ■各種加工

等辺アングル

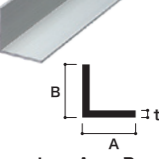

t × A × B	L=4000						
	シルバー	シルバー クリア	ブロンズ	ブラック	ステン カラー	ホワイト NEW	アイボリー NEW
1.2 × 10 × 10	●		●	●	●	●	●
1.2 × 12 × 12	●		●	●	●		
1.2 × 13 × 13	●						
1.5 × 15 × 15	●	●	●	●	●	●	●
2.0 × 15 × 15	●		●				
3.0 × 15 × 15	●						
1.5 × 19 × 19	●						
1.5 × 20 × 20	●	●					
2.0 × 20 × 20	●	●	●	●	●	●	●
3.0 × 20 × 20	●						
1.2 × 25 × 25	●						
1.5 × 25 × 25	●						
2.0 × 25 × 25	●	●	●	●	●	●	●
2.5 × 25 × 25	●						
3.0 × 25 × 25	●						
4.0 × 25 × 25	●						
1.2 × 30 × 30	●						
1.5 × 30 × 30	●	●					
2.0 × 30 × 30	●	●	●	●	●	●	●
3.0 × 30 × 30	●	●	●	●	●		
5.0 × 30 × 30	●						
2.0 × 35 × 35	●						
3.0 × 35 × 35	●						
1.5 × 38 × 38	●						
2.0 × 40 × 40	●	●	●		●	●	●
3.0 × 40 × 40	●	●	●	●	●		
4.0 × 40 × 40	●						
5.0 × 40 × 40	●						
1.5 × 45 × 45	●						
1.5 × 50 × 50	●		●				
2.0 × 50 × 50	●						
3.0 × 50 × 50	●	●	●	●	●	●	●
4.0 × 50 × 50	●						
5.0 × 50 × 50	●						
2.0 × 55 × 55	●						
2.0 × 60 × 60	●						
5.0 × 60 × 60	●						
2.2 × 70 × 70	●						
5.0 × 75 × 75	●						
2.3 × 80 × 80	●						

●寸法は全てmm単位です。

不等辺アングル

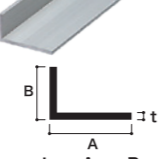

t × A × B	L=4000						
	シルバー	シルバー クリア	ブロンズ	ブラック	ステン カラー	ホワイト NEW	アイボリー NEW
1.2 × 15 × 6	●		●	●			
1.5 × 20 × 9	●						
1.5 × 25 × 9	●						
1.5 × 30 × 9	●						
1.5 × 40 × 9	●						
1.5 × 15 × 10	●						
2.0 × 15 × 10	●						
1.5 × 20 × 10	●		●	●	●		
1.5 × 25 × 10	●		●				
1.5 × 30 × 10	●		●	●	●		
1.5 × 40 × 10	●						
2.0 × 50 × 10	●		●				
2.5 × 35 × 13	●						
1.8 × 18 × 15	●						
1.5 × 20 × 15	●	●	●	●			
1.8 × 20 × 15	●						
2.0 × 20 × 15	●	●	●		●	●	●
1.5 × 25 × 15	●						
1.8 × 25 × 15	●						
2.0 × 25 × 15	●		●			●	●
1.5 × 30 × 15	●						
2.0 × 30 × 15	●		●	●	●	●	●
3.0 × 30 × 15	●						
2.0 × 35 × 15	●						
2.0 × 40 × 15	●						
1.5 × 45 × 15	●						
1.5 × 63.5 × 19	●						
2.0 × 25 × 20	●						
2.0 × 30 × 20	●	●	●		●		
3.0 × 30 × 20	●						
2.0 × 40 × 20	●	●	●	●	●	●	●
3.0 × 40 × 20	●	●					
2.0 × 50 × 20	●						
3.0 × 50 × 20	●						
3.0 × 30 × 25	●						
2.0 × 50 × 25	●					●	●
3.0 × 50 × 25	●	●	●				
1.5 × 76.2 × 25.4	●						
4.0 × 50 × 35	●						
3.0 × 80 × 40	●					●	●
5.0 × 75 × 50	●						

●寸法は全てmm単位です。

等边角パイプ

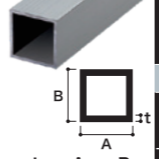

t × A × B	L=4000		5000		5000		4000		樹脂	アルミ
	B2 アルマイト	クリア 艶有	クリア 艶消	クリア 艶消	クリア 艶消	クリア 艶消	クリア 艶有	クリア 艶有	キャップ ▶p29	
1.0 × 10 × 10	●	●			●	●			○	
1.2 × 12 × 12	●	●			●	●			○	
1.5 × 15 × 15	●	●			●	●	●	●	○	
1.5 × 19 × 19	●									
1.5 × 20 × 20	●	●								
2.0 × 20 × 20	●	●		●	●		●	●	○	
1.5 × 25 × 25	●	●								
2.0 × 25 × 25	●	●		●		●	●	●	○	
1.5 × 30 × 30	●	●		●						
2.0 × 30 × 30	●	●		●	●		●	●	○	
2.0 × 35 × 35	●	●								
2.0 × 40 × 40	●	●	●	●		●	●	●	○	
2.0 × 50 × 50	●	●	●	●	●	●	●	●	○	○
3.0 × 50 × 50	●									
2.0 × 60 × 60	●	●							○	
2.0 × 70 × 70	●	●								
2.5 × 70 × 70	●									
2.0 × 75 × 75	●	●				●	●	●	○	
2.5 × 75 × 75	●									
2.5 × 80 × 80	●									
3.0 × 100 × 100		●							○	

●寸法は全てmm単位です。

不等边角パイプ

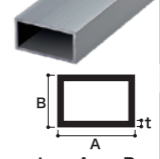

t × A × B	L=4000		5000		5000		4000		樹脂	アルミ
	B2 アルマイト	クリア 艶有	クリア 艶消	クリア 艶消	クリア 艶消	クリア 艶消	クリア 艶有	クリア 艶有	キャップ ▶p29	
1.2 × 15 × 10	●						●			
1.5 × 15 × 10	●			●						
1.5 × 20 × 10	●									
1.5 × 30 × 10	●	●				●				
2.0 × 40 × 10	●	●								
1.2 × 18 × 12	●									
1.5 × 20 × 15	●	●		●						
2.0 × 20 × 15	●	●								
1.5 × 25 × 15	●	●		●						
1.5 × 30 × 15	●	●		●	●	●	●	●	○	
2.0 × 25 × 20	●	●		●						
1.5 × 30 × 20	●	●								
2.0 × 30 × 20	●	●		●					○	
2.5 × 30 × 20	●									
1.5 × 40 × 20			●							
2.0 × 40 × 20	●	●		●	●	●	●	●	○	
1.3 × 30 × 25	●									
2.0 × 40 × 25	●	●								
2.0 × 50 × 25	●	●		●		●	●	●	○	
2.0 × 60 × 25	●	●								
2.0 × 40 × 30	●	●				●				
2.0 × 50 × 30	●	●							○	○
2.0 × 60 × 30	●	●	●	●	●	●	●	●	○	
2.0 × 70 × 30	●	●		●					○	
2.0 × 60 × 40	●	●		●						
2.0 × 80 × 40	●	●		●			●	●	○	
2.5 × 80 × 40	●	●								
2.0 × 70 × 50	●	●								○
2.0 × 100 × 30		●								
2.5 × 100 × 30	●	●								
2.0 × 100 × 50		●		●			●	●	○	○
2.5 × 100 × 50	●	●								
3.0 × 100 × 50		●								

●寸法は全てmm単位です。

アルミパイプ・チャンネル

A6063S-T5

オプション▶ ■ロット販売(当社オリジナル抗菌アルマイト仕様・別注カラー) ■切断 ■穴明 ■塗装 ■各種加工

丸パイプ

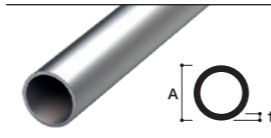

t × A	シルバー	ブラック	キャップ ▶p29
	B2 アルマイト	クリア 艶消	
	L=4000		樹脂
1.0 × 6	●		
1.0 × 9	●		○
1.0 × 10	●		
1.0 × 12	●		○
1.0 × 13	●	●	
1.0 × 15	●		○
1.0 × 16	●		
1.0 × 18	●		○
1.0 × 19	●		
2.0 × 20	●		
1.0 × 25	●		○
2.0 × 25	●		○
2.0 × 30	●		
1.5 × 32	●		○
2.0 × 32	●		○
1.5 × 38	●		
2.0 × 50	●		○

●寸法は全てmm単位です。

チャンネル

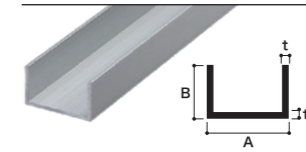

t × A × B	シルバー	シルバー クリアー	ブラック	ステン カラー
	B2 アルマイト	クリア 艶有	クリア 艶消	クリア 艶消
	L=4000			
1.0 × 5.5 × 8	●			
1.5 × 6.2 × 8.3	●			
1.0 × 6.5 × 9	●			
1.0 × 7 × 7	●			
1.0 × 7.5 × 10	●			
1.5 × 7.5 × 10	●			
1.0 × 7.5 × 25	●			
1.0 × 8.5 × 10	●			
1.0 × 10 × 10	●			
1.5 × 10 × 10		●		
1.6 × 10 × 10	●			
1.2 × 10 × 15	●			
1.0 × 11 × 5	●			
1.0 × 12 × 10	●			
2.0 × 12 × 12	●			
1.2 × 12.4 × 12.4	●			
1.0 × 14 × 10	●			
2.0 × 14 × 10	●			
2.0 × 15 × 15	●			
1.5 × 15 × 24	●			
2.0 × 18 × 10	●			
1.0 × 18 × 12	●			
2.0 × 20 × 12	●			
2.0 × 20 × 20	●			●
2.0 × 22 × 12	●			
1.0 × 22 × 13	●			
1.5 × 24 × 10	●			
2.0 × 25 × 15	●			
2.0 × 25 × 25	●			
1.0 × 27 × 15	●			
2.0 × 30 × 15	●		●	
2.4 × 30 × 20	●			
2.4 × 30 × 30	●			●
2.0 × 35 × 20	●			
2.4 × 35 × 20	●			
1.9 × 38 × 20	●			
2.0 × 40 × 20	●			
3.0 × 40 × 20	●			
2.0 × 40 × 30	●			
2.5 × 50 × 20	●			
2.5 × 50 × 25	●			
3.0 × 50 × 25	●			
3.0 × 60 × 30	●			
3.0 × 100 × 50	●			

●寸法は全てmm単位です。

アルミバー・C型チャンネル

A6063S-T5

オプション▶ ■ロット販売(当社オリジナル抗菌アルマイト仕様・別注カラー) ■切断 ■穴明 ■塗装 ■各種加工

フラットバー

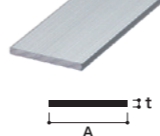

t × A	シルバー	シルバー クリア	ブロンズ	ブラック	ステン カラー	ホワイト NEW	アイボリー NEW
	B2 アルマイト	クリア 艶有	クリア 艶消	クリア 艶消	クリア 艶消	クリア 艶有	クリア 艶有
L=4000							
2.0 × 10	●		●				
3.0 × 10	●		●				
5.0 × 10	●						
3.0 × 12	●		●				
4.0 × 12	●						
2.0 × 15	●		●				
3.0 × 15	●		●				
4.0 × 15	●						
5.0 × 15	●						
6.0 × 15	●						
2.0 × 20	●		●	●	●	●	●
3.0 × 20	●	●	●	●	●		
4.0 × 20	●						
5.0 × 20	●						
2.0 × 25	●				●	●	●
3.0 × 25	●	●	●				
4.0 × 25	●						
5.0 × 25	●						
2.0 × 30	●		●	●			
3.0 × 30	●	●	●		●	●	●
4.0 × 30	●						
5.0 × 30	●		●				
2.0 × 35	●						
3.0 × 35	●						
2.0 × 40	●						
3.0 × 40	●	●	●	●	●	●	●
4.0 × 40	●						
5.0 × 40	●						
6.0 × 40	●						
1.5 × 50	●			●	●	●	●
2.0 × 50	●						
3.0 × 50	●	●	●		●	●	●
4.0 × 50	●						
5.0 × 50	●			●	●		
6.0 × 50	●						
3.0 × 60	●		●			●	●
5.0 × 60	●						
2.0 × 64	●						
2.0 × 67	●						
3.0 × 70	●					●	●
5.0 × 70	●						
6.0 × 75	●						
2.0 × 88	●						
3.0 × 100	●					●	●
5.0 × 100	●						
6.0 × 100	●						
3.0 × 112	●						

●寸法は全てmm単位です。

T型バー

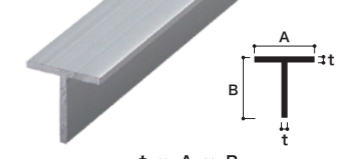

t × A × B	シルバー
L=4000	
1.0 × 15 × 16	●
1.2 × 15 × 16.2	●
1.6 × 17 × 11.5	●
2.0 × 20 × 20	●
3.0 × 23 × 25	●
2.0 × 40 × 30	●

●寸法は全てmm単位です。

Z型バー

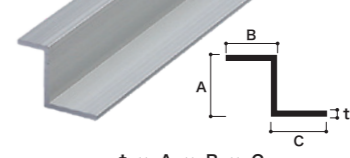

t × A × B × C	シルバー
L=4000	
1.0 × 10.5 × 11.5 × 11.5	●
2.0 × 23.5 × 12.5 × 21	●

●寸法は全てmm単位です。

C型チャンネル

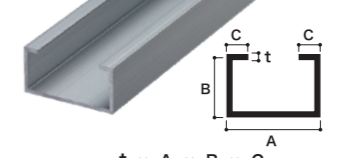

t × A × B × C	シルバー
L=4000	
1.5 × 33 × 18 × 6.5	●
2.0 × 44 × 22 × 7	●
3.0 × 70 × 23 × 10	●
3.0 × 100 × 25 × 20	●

●寸法は全てmm単位です。

H型バー

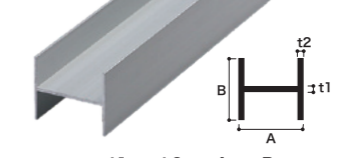

t1 × t2 × A × B	シルバー
L=4000	
1.5 × 1.2 × 34.4 × 30	●

●寸法は全てmm単位です。

受注生産 アルミ形材 一覧表

A6063S-T5

オプション▶ ■各種表面処理 ■当社オリジナル抗菌処理 ■切断 ■穴明 ■塗装 ■各種加工

押出 丸パイプ

受注生産



D × t	D × t
6 × 1.0	33 × 3.0
9 × 1.0	34 × 2.0 ※
10 × 1.0 ※	35 × 1.5
12 × 1.0	35 × 2.0
13 × 1.0	35 × 3.0
14 × 1.0	35 × 3.5
15 × 1.0	38 × 1.2
15 × 1.5 ※	38 × 1.5
16 × 1.0	38 × 2.0
16 × 1.1	38 × 2.5
16 × 1.5	38 × 3.0
16 × 2.0	40 × 1.5
18 × 1.0	40 × 2.0
19 × 1.0	40 × 3.0
19 × 1.5	40 × 4.0
20 × 1.0	45 × 1.5
20 × 1.5	45 × 2.0
20 × 2.0	45 × 4.0
20 × 2.5	48 × 3.0
20 × 3.0	50 × 1.5
22 × 1.0	50 × 2.0
22 × 1.2	50 × 2.5
22 × 1.5	50 × 5.0
22 × 2.0	55 × 2.0
22 × 3.0	55 × 3.0
25 × 1.0	55 × 5.0
25 × 1.3	60 × 2.0
25 × 1.5	60 × 3.0
25 × 2.0	60 × 5.0
25 × 2.5	65 × 3.0
25 × 3.0	70 × 2.0
28 × 1.5	70 × 3.0
28 × 2.0	70 × 4.0
28 × 3.0	75 × 2.0
28 × 5.0	75 × 3.0
30 × 1.0	80 × 3.0
30 × 1.5	80 × 4.0
30 × 2.0	85 × 2.0
30 × 2.5	90 × 3.0
30 × 3.0	90 × 4.0
32 × 1.5	100 × 2.0 ※
32 × 2.0	100 × 3.0

押出 丸棒

受注生産



D
6
8
10 ※
12
16
18
19
20
22
24 ※
25
28
30

押出 等辺角パイプ

受注生産

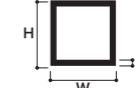

W × H × t
10 × 10 × 1.0
12 × 12 × 1.2
15 × 15 × 1.5
19 × 19 × 1.5
20 × 20 × 1.5
20 × 20 × 2.0
20 × 20 × 2.0 R付
25 × 25 × 1.2
25 × 25 × 1.5
25 × 25 × 2.0
30 × 30 × 1.5
30 × 30 × 2.0
30 × 30 × 2.0 R付
30 × 30 × 3.0
35 × 35 × 2.0
36 × 36 × 3.0 R付
38 × 38 × 2.0 R付
40 × 40 × 2.0
40 × 40 × 3.0
50 × 50 × 1.3 R付
50 × 50 × 1.8
50 × 50 × 1.8 R付
50 × 50 × 2.0
50 × 50 × 2.5
50 × 50 × 3.0 R付
60 × 60 × 1.6 R付
60 × 60 × 2.3
65 × 65 × 2.0 R付
70 × 70 × 2.0
75 × 75 × 2.0 R付

押出 不等辺角パイプ

受注生産

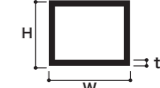

W × H × t	W × H × t
15 × 10 × 1.2	45 × 10 × 1.5
15 × 10 × 1.5	50 × 10 × 2.0
15 × 10 × 1.1	50 × 25 × 1.5
20 × 15 × 1.5	50 × 25 × 2.0
20 × 15 × 2.0	50 × 30 × 1.5
22 × 10 × 1.5 ※	50 × 30 × 2.0
25 × 15 × 1.5	60 × 20 × 1.2
25 × 20 × 2.0	60 × 25 × 2.0
30 × 7.5 × 1.0 ※	60 × 30 × 1.5
30 × 10 × 1.5	60 × 30 × 1.9
30 × 15 × 1.5	60 × 30 × 2.0
30 × 15 × 2.0	60 × 30 × 2.5
30 × 20 × 1.5	60 × 40 × 2.0
30 × 20 × 2.0	70 × 30 × 2.0
30 × 20 × 2.0 R付	70 × 30 × 3.0
30 × 20 × 2.5	70 × 50 × 2.0
30 × 25 × 1.3	80 × 20 × 1.5
40 × 10 × 2.0	80 × 30 × 1.5
40 × 20 × 1.2	80 × 40 × 2.0
40 × 20 × 1.5	80 × 40 × 2.5
40 × 20 × 1.8	89 × 30 × 1.5
40 × 20 × 2.0	100 × 30 × 2.0
40 × 25 × 2.0	100 × 40 × 1.8
40 × 30 × 1.5	100 × 50 × 1.9
40 × 30 × 2.0	100 × 50 × 2.0
44.5 × 24.5 × 2.0 R付	100 × 50 × 2.5
	100 × 50 × 3.0

押出 角棒

受注生産

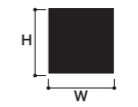

9

受注生産 アルミ形材 一覧表

A6063S-T5 オプション▶ ■各種表面処理 ■当社オリジナル抗菌処理 ■切断 ■穴開 ■塗装 ■各種加工

押出 等辺アングル

受注生産

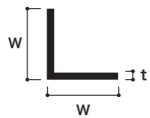

W × t	W × t
10 × 1.2	30 × 3.0
12 × 0.8 ※	30 × 5.0
12 × 1.0	35 × 2.0
12 × 1.2	35 × 3.0
13 × 1.2	38 × 0.9 ※
15 × 0.8 ※	38 × 1.2
15 × 1.0	38 × 1.5
15 × 1.5	38 × 2.0
15 × 2.0	40 × 2.0
15 × 3.0	40 × 3.0
19 × 0.8 ※	40 × 4.0
19 × 1.0	40 × 5.0
19 × 1.5	45 × 1.5
20 × 1.5	50 × 1.5
20 × 2.0	50 × 2.0
20 × 3.0	50 × 3.0
25 × 0.8 ※	50 × 4.0
25 × 1.2	50 × 4.0 R付
25 × 1.5	50 × 5.0
25 × 2.0	50 × 5.0 R付
25 × 3.0	50 × 6.0 R付
25 × 4.0	60 × 5.0
30 × 0.8 ※	60 × 6.0 R付
30 × 1.0	75 × 5.0
30 × 1.2	75 × 6.0 R付
30 × 1.5	80 × 2.3
30 × 2.0	

押出 不等辺アングル

受注生産

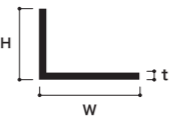

W × H × t	W × H × t
12 × 6 × 1.2	36 × 20 × 1.2 R付
15 × 6 × 1.2	40 × 9 × 1.5
15 × 10 × 1.4 ※	40 × 10 × 1.3
15 × 10 × 1.5	40 × 10 × 1.5
15 × 10 × 1.9	40 × 15 × 2.0
15 × 10 × 2.0	40 × 20 × 1.5
15 × 12 × 1.8 ※	40 × 20 × 2.0
20 × 9 × 1.5	40 × 20 × 3.0
20 × 10 × 1.5	40 × 24.5 × 3.0 ※
20 × 10 × 2.0	40 × 27 × 2.0 R付
20 × 15 × 1.4	40 × 30 × 3.0
20 × 15 × 1.5	45 × 15 × 1.5
20 × 15 × 1.8	45 × 30 × 4.0 R付
20 × 15 × 2.0	50 × 10 × 2.0
25 × 9 × 1.5	50 × 20 × 2.0
25 × 10 × 1.5	50 × 20 × 3.0
25 × 15 × 1.5	50 × 25 × 3.0
25 × 15 × 1.8	50 × 30 × 2.0
25 × 15 × 2.0	50 × 30 × 4.0
25 × 20 × 1.8	60 × 40 × 3.0 R付
25 × 20 × 2.0	60 × 50 × 4.0 R付
30 × 9 × 1.5	63.5 × 19 × 1.5
30 × 10 × 1.3	70 × 50 × 3.0 R付
30 × 10 × 1.5	75 × 50 × 5.0
30 × 15 × 2.0	75 × 50 × 5.0 R付
30 × 20 × 2.0	76.2 × 25.4 × 1.5
30 × 20 × 3.0	80 × 40 × 3.0
30 × 25 × 3.0	90 × 50 × 1.7
35 × 13 × 2.5	95 × 50 × 5.0 R付
35 × 15 × 2.0	100 × 50 × 3.0

押出 フラットバー

受注生産



W × t	W × t
9 × 9.0 (角棒)	35 × 2.0
10 × 2.0	35 × 3.0
10 × 3.0	38 × 3.0 R付
10 × 5.0	40 × 2.0
12 × 2.0 R付	40 × 3.0
12 × 3.0	40 × 4.0
15 × 2.0	40 × 5.0
15 × 3.0	40 × 6.0
15 × 4.0	50 × 1.5
15 × 5.0	50 × 2.0
15 × 5.0 R付	50 × 3.0
15 × 6.0	50 × 4.0
15 × 10.0 R付	50 × 5.0
19.5 × 3.0 R付	50 × 6.0
20 × 1.5 R付	50 × 10.0 R付 ※
20 × 2.0	55 × 2.0 R付 ※
20 × 3.0	60 × 3.0
20 × 4.0	60 × 5.0
20 × 5.0	60 × 5.0 R付
20 × 6.0	60 × 6.0
25 × 2.0	64 × 2.0
25 × 3.0	65 × 2.0 R付
25 × 4.0	67 × 2.0
25 × 5.0	70 × 3.0
25 × 10.0 R付	70 × 5.0
30 × 2.0	75 × 6.0
30 × 3.0	88 × 2.0
30 × 3.0 R付	100 × 3.0
30 × 4.0	100 × 5.0
30 × 5.0 R付	100 × 6.0
30 × 15.0	112 × 3.0
32 × 3.0	127 × 3.0

押出 等辺チャンネル

受注生産

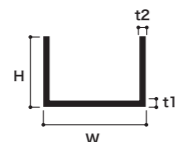

W × H × t1 × t2	W × H × t1 × t2
5.5 × 8 × 1.0 × 1.0	22 × 13 × 1.0 × 1.0
6.2 × 8.3 × 1.5 × 1.5	25 × 15 × 2.0 × 2.0
6.5 × 9 × 1.0 × 1.0	25 × 25 × 2.0 × 2.0
7 × 7 × 1.0 × 1.0	27 × 15 × 1.0 × 1.0
7.5 × 10 × 1.5 × 1.5	30 × 15 × 2.0 × 2.0
7.5 × 25 × 1.0 × 1.0	30 × 20 × 2.4 × 2.4
8.5 × 10 × 1.0 × 1.0	30 × 30 × 2.4 × 2.4
10 × 10 × 1.5 × 1.5	35 × 20 × 2.0 × 2.0
10 × 10 × 1.6 × 1.6	35 × 20 × 2.4 × 2.4
12 × 12 × 2.0 × 2.0	40 × 20 × 2.0 × 2.0
12 × 15 × 1.0 × 1.0	40 × 20 × 3.0 × 3.0
12.4 × 12.4 × 1.2 × 1.2	43.5 × 15 × 3.0 × 4.0 R付
14 × 10 × 2.0 × 2.0	50 × 25 × 2.5 × 2.5
14.4 × 14.4 × 1.2 × 1.2	50 × 25 × 3.0 × 3.0
15 × 15 × 2.0 × 2.0	60 × 30 × 3.0 × 3.0
18 × 10 × 1.6 × 1.6 ※	60 × 30 × 4.0 × 4.0
18 × 10 × 2.0 × 2.0	70 × 30 × 3.9 × 3.9 R付
20 × 12 × 2.0 × 2.0	75 × 40 × 6.0 × 6.0 R付
20 × 20 × 2.0 × 2.0	100 × 50 × 3.0 × 3.0
22 × 12 × 2.0 × 2.0	149 × 15 × 3.0 × 4.0 R付

押出 不等辺チャンネル

受注生産

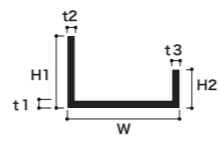

W × H1 × H2 × t1 × t2 × t3
8.2 × 25 × 8 × 1.1 × 1.1 × 1.1
10.2 × 25 × 8 × 1.1 × 1.1 × 1.1
20 × 15 × 3 × 1.5 × 1.5 × 1.5
25 × 25 × 4.2 × 1.2 × 1.2 × 1.2

キャップ(内栓タイプ)

- 商品は叩き込み型になります。
パイプのサイズに対して樹脂キャップのサイズが若干異なる商品もございますが、取り付け可能です。
【キャップがゆるい場合】…接着剤で固定してください。
【キャップがきつい場合】…ジャバラに切れ込みを入れてください。
- ご注文の際には、パイプのサイズと肉厚と色をご指示ください。

樹脂製 ポリエチレン

丸パイプ用



在庫品 対応する丸パイプの肉厚サイズ▶p23

外径	肉厚	外径	肉厚
9.0φ	1.0~1.2	25.0φ	1.2~1.6
12.0φ	1.0~1.2	32.0φ	1.2~2.0
15.0φ	1.2~1.6	50.0φ	1.2~1.6
18.0φ	1.2~1.6		

取寄品 対応する丸パイプの肉厚サイズ

外径	肉厚	外径	肉厚
8.0φ	1.0~1.2	42.7φ	1.2~1.6
10.0φ	1.0~1.2	42.7φ	2.3
12.7φ	1.0~1.2	42.7φ	3.2
13.8φ	2.3	48.6φ	1.2~1.6
17.3φ	2.3	48.6φ	2.3
21.7φ	1.2~2.3	48.6φ	3.2
22.2φ	1.2~1.6	50.8φ	2.3~3.2
25.4φ	2.0	60.5φ	1.2~1.6
27.2φ	1.2~1.9	60.5φ	2.3~3.2
27.2φ	2.8	76.3φ	1.2~2.3
28.0φ	1.2~1.6	76.3φ	2.8~3.2
28.6φ	1.2~2.0	76.3φ	4.5
34.0φ	1.2~1.6	89.1φ	1.2~2.3
34.0φ	2.3	89.1φ	2.8~3.2
34.0φ	3.2	89.1φ	4.5
35.0φ	1.2~1.6	101.6φ	1.2~2.3
38.1φ	1.2~1.6	101.6φ	3.2~4.5
38.1φ	2.3	114.3φ	3.5~4.5
38.1φ	3.2	139.8φ	3.5~4.5
		165.2φ	3.5~5.0

等辺角パイプ用



在庫品 対応する等辺角パイプの肉厚サイズ▶p21

外径	肉厚	外径	肉厚
10角	1.0~1.6	30角	1.2~1.6
12角	1.0~1.6	40角	1.2~1.6
15角	1.2~1.6	50角	1.2~1.6
20角	1.2~1.6	60角	1.2~2.3
25角	1.6~2.0	75角	1.2~2.3
		100角	1.2~3.2

取寄品 対応する角パイプの肉厚サイズ

外径	肉厚	外径	肉厚
9角	1.0~1.6	40角	2.3
13角	1.0~1.6	40角	3.2
14角	1.2~1.6	45角	1.2~1.6
16角	1.2~1.6	50角	2.3
19角	1.2~1.6	50角	3.2
21角	1.2~1.6	60角	3.2
22角	1.2~1.6	90角	1.2~2.3
24角	1.2~1.6	100角	4.5~6.0
25角	1.2~1.6	125角	2.3~4.5
28角	1.2~1.6	125角	6.0
30角	2.3~3.2	150角	3.2~5.0
31角	1.2~1.6		
32角	1.2~1.6		
35角	1.2~1.6		
38角	1.2~1.6		
38角	2.3		

不等辺角パイプ用



在庫品 対応する不等辺角パイプの肉厚サイズ▶p21

外径	肉厚	外径	肉厚
30 × 15	1.2~1.6	50 × 30	1.2~1.6
30 × 20	2.0	60 × 30	1.2~1.6
40 × 20	1.2~2.0	70 × 30	1.2~2.3
		80 × 40	1.2~1.6
		100 × 50	1.2~2.3

取寄品 対応する角パイプの肉厚サイズ

外径	肉厚	外径	肉厚
19 × 10	1.2~1.6	70 × 25	1.2~1.6
22 × 10	1.2~1.6	70 × 30	3.2
24 × 14	1.2~1.6	75 × 25	1.2~1.6
25 × 12	1.2~1.6	75 × 45	1.2~2.3
30 × 20	1.2~1.6	75 × 45	3.2
32 × 14	1.2~1.6	90 × 30	1.2~1.6
32 × 16	1.2~1.6	90 × 45	1.2~2.3
40 × 16	1.2~1.6	100 × 40	1.2~1.6
40 × 25	1.2~1.6	100 × 50	3.5
40 × 30	1.2~1.6	125 × 75	2.0~3.2
50 × 16	1.2~1.6	125 × 75	4.5
50 × 18	1.2~1.6	150 × 50	1.6~3.2
50 × 20	1.2~1.6	150 × 75	2.3~3.2
50 × 20	2.0	150 × 100	3.2~4.5
50 × 26	1.2~1.6		
50 × 30	2.3~3.5		
60 × 30	2.3		

アルミ製 A6063S-T5

ビスもしくは接着剤にてお取り付けください。



使用例

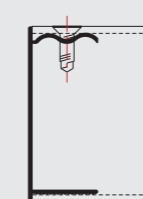

在庫品

使用 角パイプ 適用サイズ	在庫品色			
	シルバー 塗装	ブロンズ 塗装	ブラック 塗装	ステンカラー 塗装
2.0 × 50 × 25	■	■	■	■
2.0 × 50 × 30	■	■	■	■
2.0 × 50 × 50	■	■	■	■
2.0 × 70 × 50	■	■	■	■
2.0 × 100 × 50	■	■	■	■