

Color Variation

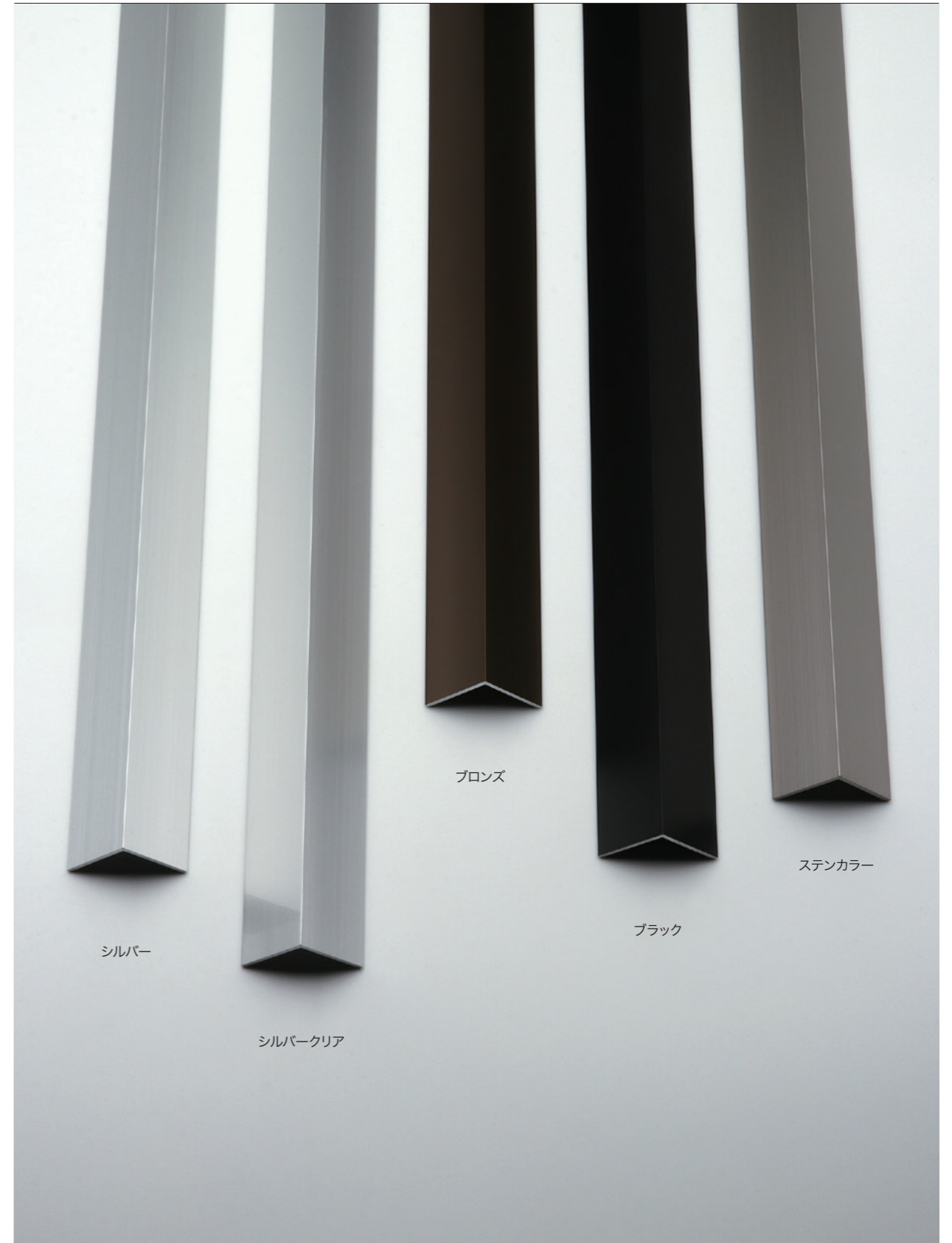

※印刷の都合上、実際の色と異なる場合があります

アルミアングル・角パイプ

A6063S-T5 オプション▶ ■ロット販売(当社オリジナル抗菌アルマイト仕様・別注カラー) ■切断 ■穴明 ■塗装 ■各種加工

等辺アングル

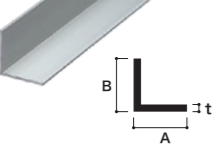

t × A × B	L=4000				
	シルバー アルマイト	シルバー クリア	ブロンズ 艶消	ブラック 艶消	ステン カラー
1.2 × 10 × 10	●		●	●	●
1.2 × 12 × 12	●		●	●	●
1.2 × 13 × 13	●				
1.5 × 15 × 15	●	●	●	●	●
2.0 × 15 × 15	●		●		
3.0 × 15 × 15	●				
1.5 × 19 × 19	●				
1.5 × 20 × 20	●	●			
2.0 × 20 × 20	●	●	●	●	●
3.0 × 20 × 20	●				
1.2 × 25 × 25	●				
1.5 × 25 × 25	●				
2.0 × 25 × 25	●	●	●	●	●
2.5 × 25 × 25	●				
3.0 × 25 × 25	●				
4.0 × 25 × 25	●				
1.2 × 30 × 30	●				
1.5 × 30 × 30	●	●			
2.0 × 30 × 30	●	●	●	●	●
3.0 × 30 × 30	●	●	●	●	●
5.0 × 30 × 30	●				
2.0 × 35 × 35	●				
3.0 × 35 × 35	●				
1.5 × 38 × 38	●				
2.0 × 40 × 40	●	●	●		●
3.0 × 40 × 40	●	●	●	●	●
4.0 × 40 × 40	●				
5.0 × 40 × 40	●				
1.5 × 45 × 45	●				
1.5 × 50 × 50	●		●		
2.0 × 50 × 50	●				
3.0 × 50 × 50	●	●	●	●	●
4.0 × 50 × 50	●				
5.0 × 50 × 50	●				
2.0 × 55 × 55	●				
2.0 × 60 × 60	●				
5.0 × 60 × 60	●				
2.2 × 70 × 70	●				
5.0 × 75 × 75	●				
2.3 × 80 × 80	●				

●寸法は全てmm単位です。

不等辺アングル

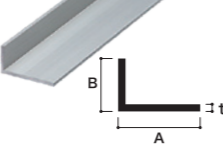

t × A × B	L=4000				
	シルバー アルマイト	シルバー クリア	ブロンズ 艶消	ブラック 艶消	ステン カラー
1.2 × 15 × 6	●		●	●	
1.5 × 20 × 9	●				
1.5 × 25 × 9	●				
1.5 × 30 × 9	●				
1.5 × 40 × 9	●				
1.5 × 15 × 10	●				
1.9 × 15 × 10	●				
2.0 × 15 × 10	●				
1.5 × 20 × 10	●		●	●	●
1.5 × 25 × 10	●		●		
1.5 × 30 × 10	●		●	●	●
1.5 × 40 × 10	●				
2.0 × 50 × 10	●		●		
2.5 × 35 × 13	●				
1.8 × 18 × 15	●				
1.5 × 20 × 15	●	●	●	●	
1.8 × 20 × 15	●				
2.0 × 20 × 15	●	●	●		●
1.5 × 25 × 15	●				
1.8 × 25 × 15	●		●		
2.0 × 25 × 15	●		●		
1.5 × 30 × 15	●				
2.0 × 30 × 15	●		●	●	●
3.0 × 30 × 15	●				
2.0 × 35 × 15	●				
2.0 × 40 × 15	●				
1.5 × 45 × 15	●				
1.5 × 63.5 × 19	●				
2.0 × 25 × 20	●				
2.0 × 30 × 20	●	●	●		●
3.0 × 30 × 20	●				
2.0 × 40 × 20	●	●	●	●	●
3.0 × 40 × 20	●	●			
2.0 × 50 × 20	●				
3.0 × 50 × 20	●				
3.0 × 30 × 25	●				
2.0 × 50 × 25	●				
3.0 × 50 × 25	●	●	●		
1.5 × 76.2 × 25.4	●				
4.0 × 50 × 35	●				
3.0 × 80 × 40	●				
5.0 × 75 × 50	●				

●寸法は全てmm単位です。

等辺角パイプ

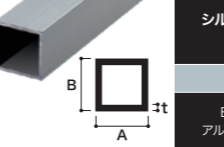

t × A × B	キャップ ▶p29					樹脂	アルミ
	B2 アルマイト	クリア 艶有	クリア 艶消	クリア 艶消	クリア 艶消		
1.0 × 10 × 10	●	●		●	●	○	
1.2 × 12 × 12	●	●		●	●	○	
1.5 × 15 × 15	●	●		●	●	○	
1.5 × 19 × 19	●						
1.5 × 20 × 20	●	●					
2.0 × 20 × 20	●		●	●	●	○	
1.5 × 25 × 25	●		●				
2.0 × 25 × 25	●	●		●	●	○	
1.5 × 30 × 30	●		●	●			
2.0 × 30 × 30	●		●	●	●	○	
2.0 × 35 × 35	●	●					
2.0 × 40 × 40	●	●	●	●	●	○	
2.0 × 50 × 50	●	●	●	●	●	○	○
3.0 × 50 × 50	●						
2.0 × 60 × 60	●	●				○	
2.0 × 70 × 70	●		●				
2.5 × 70 × 70	●						
2.0 × 75 × 75	●	●			●	○	
2.5 × 75 × 75	●						
2.5 × 80 × 80	●						
3.0 × 100 × 100		●				○	

●寸法は全てmm単位です。

不等辺角パイプ

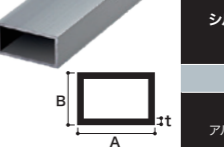

t × A × B	キャップ ▶p29					樹脂	アルミ
	B2 アルマイト	クリア 艶有	クリア 艶消	クリア 艶消	クリア 艶消		
1.2 × 15 × 10	●				●		
1.5 × 15 × 10	●		●				
1.5 × 20 × 10	●						
1.5 × 30 × 10	●	●			●		
2.0 × 40 × 10	●	●					
1.2 × 18 × 12	●						
1.5 × 20 × 15	●	●		●			
2.0 × 20 × 15	●	●					
1.5 × 25 × 15	●	●		●			
1.5 × 30 × 15	●	●		●	●	○	
2.0 × 25 × 20	●	●		●			
1.5 × 30 × 20		●					
2.0 × 30 × 20	●	●		●		○	
2.5 × 30 × 20		●					
1.5 × 40 × 20			●				
2.0 × 40 × 20	●		●	●	●	○	
1.3 × 30 × 25	●						
2.0 × 40 × 25	●	●					
2.0 × 50 × 25	●		●	●	●	○	
2.0 × 60 × 25	●	●					
2.0 × 40 × 30	●	●			●		
2.0 × 50 × 30	●	●				○	○
2.0 × 60 × 30	●	●	●	●	●	○	
2.0 × 70 × 30	●	●		●		○	
2.0 × 60 × 40	●	●		●			
2.0 × 80 × 40	●	●		●		○	
2.5 × 80 × 40	●	●					
2.0 × 70 × 50	●	●					○
2.0 × 100 × 30		●					
2.5 × 100 × 30	●	●					
2.0 × 100 × 50			●	●		○	○
2.5 × 100 × 50	●	●					
3.0 × 100 × 50		●					

●寸法は全てmm単位です。

アルミパイプ・チャンネル

A6063S-T5

オプション▶ ■ロット販売(当社オリジナル抗菌アルマイト仕様・別注カラー) ■切断 ■穴明 ■塗装 ■各種加工

丸パイプ

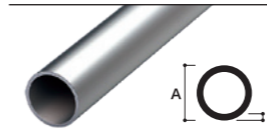

t × A	シルバー	ブラック	キャップ ▶p29
	B2 アルマイト	クリア 艶消	
	L=4000		樹脂
1.0 × 6	●		
1.0 × 9	●		○
1.0 × 10	●		
1.0 × 12	●		○
1.0 × 13	●	●	
1.0 × 15	●		○
1.0 × 16	●		
1.0 × 18	●		○
1.0 × 19	●		
2.0 × 20	●		
1.0 × 25	●		○
2.0 × 25	●		○
2.0 × 30	●		
1.5 × 32	●		○
2.0 × 32	●		○
1.5 × 38	●		
2.0 × 50	●		○

●寸法は全てmm単位です。

チャンネル

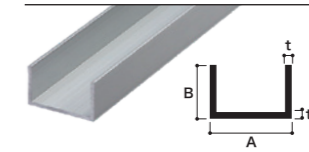

t × A × B	シルバー	シルバー クリアー	ブラック	ステン カラー
	B2 アルマイト	クリア 艶有	クリア 艶消	クリア 艶消
	L=4000			
1.0 × 5.5 × 8	●			
1.5 × 6.2 × 8.3	●			
1.0 × 6.5 × 9	●			
1.0 × 7 × 7	●			
1.0 × 7.5 × 10	●			
1.5 × 7.5 × 10	●			
1.0 × 7.5 × 25	●			
1.0 × 8.5 × 10	●			
1.0 × 10 × 10	●			
1.5 × 10 × 10		●		
1.6 × 10 × 10	●			
1.2 × 10 × 15	●			
1.0 × 11 × 5	●			
1.0 × 12 × 10	●			
2.0 × 12 × 12	●			
1.2 × 12.4 × 12.4	●			
1.0 × 14 × 10	●			
2.0 × 14 × 10	●			
2.0 × 15 × 15	●			
1.5 × 15 × 24	●			
2.0 × 18 × 10	●			
1.0 × 18 × 12	●			
2.0 × 20 × 12	●			
2.0 × 20 × 20	●			●
2.0 × 22 × 12	●			
1.0 × 22 × 13	●			
1.5 × 24 × 10	●			
2.0 × 25 × 15	●			
2.0 × 25 × 25	●			
1.0 × 27 × 15	●			
2.0 × 30 × 15	●		●	
2.4 × 30 × 20	●			
2.4 × 30 × 30	●			●
2.0 × 35 × 20	●			
2.4 × 35 × 20	●			
1.9 × 38 × 20	●			
2.0 × 40 × 20	●			
3.0 × 40 × 20	●			
2.0 × 40 × 30	●			
2.5 × 50 × 20	●			
2.5 × 50 × 25	●			
3.0 × 50 × 25	●			
3.0 × 60 × 30	●			
3.0 × 100 × 50	●			

●寸法は全てmm単位です。

アルミバー・C型チャンネル

A6063S-T5

オプション▶ ■ロット販売(当社オリジナル抗菌アルマイト仕様・別注カラー) ■切断 ■穴明 ■塗装 ■各種加工

フラットバー

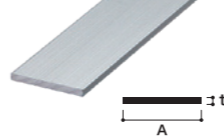

t × A	シルバー	シルバー クリアー	ブロンズ	ブラック	ステン カラー
	B2 アルマイト	クリア 艶有	クリア 艶消	クリア 艶消	クリア 艶消
	L=4000				
2.0 × 10	●		●		
3.0 × 10	●		●		
5.0 × 10	●				
3.0 × 12	●		●		
4.0 × 12	●				
2.0 × 15	●		●		
3.0 × 15	●		●		
4.0 × 15	●				
5.0 × 15	●				
6.0 × 15	●				
2.0 × 20	●		●	●	●
3.0 × 20	●	●	●	●	●
4.0 × 20	●				
5.0 × 20	●				
2.0 × 25	●				●
3.0 × 25	●	●	●		
4.0 × 25	●				
5.0 × 25	●				
2.0 × 30	●		●	●	
3.0 × 30	●	●	●		●
4.0 × 30	●				
5.0 × 30	●		●		
2.0 × 35	●				
3.0 × 35	●				
2.0 × 40	●				
3.0 × 40	●	●	●	●	●
4.0 × 40	●				
5.0 × 40	●				
6.0 × 40	●				
1.5 × 50	●			●	●
2.0 × 50	●				
3.0 × 50	●	●	●		●
4.0 × 50	●				
5.0 × 50	●			●	●
6.0 × 50	●				
3.0 × 60	●		●		
5.0 × 60	●				
2.0 × 64	●				
2.0 × 67	●				
3.0 × 70	●				
5.0 × 70	●				
6.0 × 75	●				
2.0 × 88	●				
3.0 × 100	●				
5.0 × 100	●				
6.0 × 100	●				
3.0 × 112	●				

●寸法は全てmm単位です。

T型バー

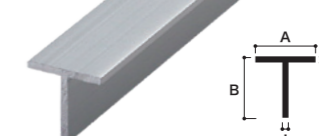

t × A × B	シルバー
	B2 アルマイト
	L=4000
1.0 × 15 × 16	●
1.2 × 15 × 16.2	●
1.6 × 17 × 11.5	●
2.0 × 20 × 20	●
3.0 × 23 × 25	●
2.0 × 40 × 30	●

●寸法は全てmm単位です。

Z型バー

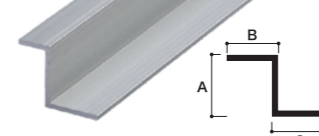

t × A × B × C	シルバー
	B2 アルマイト
	L=4000
1.0 × 10.5 × 11.5 × 11.5	●
2.0 × 23.5 × 12.5 × 21	●

●寸法は全てmm単位です。

C型チャンネル

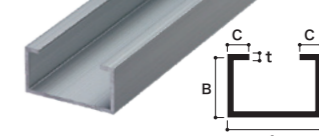

t × A × B × C	シルバー
	B2 アルマイト
	L=4000
1.5 × 33 × 18 × 6.5	●
2.0 × 44 × 22 × 7	●
3.0 × 70 × 23 × 10	●
3.0 × 100 × 25 × 20	●

●寸法は全てmm単位です。

H型バー

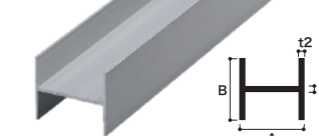

t1 × t2 × A × B	シルバー
	B2 アルマイト
	L=4000
1.5 × 1.2 × 34.4 × 30	●

●寸法は全てmm単位です。

受注生産 アルミ形材 一覧表

A6063S-T5

オプション▶ ■各種表面処理 ■当社オリジナル抗菌処理 ■切断 ■穴明 ■塗装 ■各種加工

押出 丸パイプ

受注生産



D × t	D × t
6 × 1.0	33 × 3.0
9 × 1.0	34 × 2.0 ※
10 × 1.0 ※	35 × 1.5
12 × 1.0	35 × 2.0
13 × 1.0	35 × 3.0
14 × 1.0	35 × 3.5
15 × 1.0	38 × 1.2
15 × 1.5 ※	38 × 1.5
16 × 1.0	38 × 2.0
16 × 1.1	38 × 2.5
16 × 1.5	38 × 3.0
16 × 2.0	40 × 1.5
18 × 1.0	40 × 2.0
19 × 1.0	40 × 3.0
19 × 1.5	40 × 4.0
20 × 1.0	45 × 1.5
20 × 1.5	45 × 2.0
20 × 2.0	45 × 4.0
20 × 2.5	48 × 3.0
20 × 3.0	50 × 1.5
22 × 1.0	50 × 2.0
22 × 1.2	50 × 2.5
22 × 1.5	50 × 5.0
22 × 2.0	55 × 2.0
22 × 3.0	55 × 3.0
25 × 1.0	55 × 5.0
25 × 1.3	60 × 2.0
25 × 1.5	60 × 3.0
25 × 2.0	60 × 5.0
25 × 2.5	65 × 3.0
25 × 3.0	70 × 2.0
28 × 1.5	70 × 3.0
28 × 2.0	70 × 4.0
28 × 3.0	75 × 2.0
28 × 5.0	75 × 3.0
30 × 1.0	80 × 3.0
30 × 1.5	80 × 4.0
30 × 2.0	85 × 2.0
30 × 2.5	90 × 3.0
30 × 3.0	90 × 4.0
32 × 1.5	100 × 2.0 ※
32 × 2.0	100 × 3.0

押出 丸棒

受注生産



D
6
8
10 ※
12
16
18
19
20
22
24 ※
25
28
30

押出 等辺角パイプ

受注生産

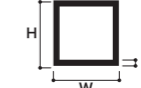

W × H × t
10 × 10 × 1.0
12 × 12 × 1.2
15 × 15 × 1.5
19 × 19 × 1.5
20 × 20 × 1.5
20 × 20 × 2.0
20 × 20 × 2.0 R付
25 × 25 × 1.2
25 × 25 × 1.5
25 × 25 × 2.0
30 × 30 × 1.5
30 × 30 × 2.0
30 × 30 × 2.0 R付
30 × 30 × 3.0
35 × 35 × 2.0
36 × 36 × 3.0 R付
38 × 38 × 2.0 R付
40 × 40 × 2.0
40 × 40 × 3.0
50 × 50 × 1.3 R付
50 × 50 × 1.8
50 × 50 × 1.8 R付
50 × 50 × 2.0
50 × 50 × 2.5
50 × 50 × 3.0 R付
60 × 60 × 1.6 R付
60 × 60 × 2.3
65 × 65 × 2.0 R付
70 × 70 × 2.0
75 × 75 × 2.0 R付

押出 不等辺角パイプ

受注生産

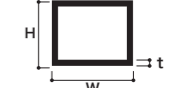

W × H × t	W × H × t
15 × 10 × 1.2	45 × 10 × 1.5
15 × 10 × 1.5	50 × 10 × 2.0
15 × 10 × 1.1	50 × 25 × 1.5
20 × 15 × 1.5	50 × 25 × 2.0
20 × 15 × 2.0	50 × 30 × 1.5
22 × 10 × 1.5 ※	50 × 30 × 2.0
25 × 15 × 1.5	60 × 20 × 1.2
25 × 20 × 2.0	60 × 25 × 2.0
30 × 7.5 × 1.0 ※	60 × 30 × 1.5
30 × 10 × 1.5	60 × 30 × 1.9
30 × 15 × 1.5	60 × 30 × 2.0
30 × 15 × 2.0	60 × 30 × 2.5
30 × 20 × 1.5	60 × 40 × 2.0
30 × 20 × 2.0	70 × 30 × 2.0
30 × 20 × 2.0 R付	70 × 30 × 3.0
30 × 20 × 2.5	70 × 50 × 2.0
30 × 25 × 1.3	80 × 20 × 1.5
40 × 10 × 2.0	80 × 30 × 1.5
40 × 20 × 1.2	80 × 40 × 2.0
40 × 20 × 1.5	80 × 40 × 2.5
40 × 20 × 1.8	89 × 30 × 1.5
40 × 20 × 2.0	100 × 30 × 2.0
40 × 25 × 2.0	100 × 40 × 1.8
40 × 30 × 1.5	100 × 50 × 1.9
40 × 30 × 2.0	100 × 50 × 2.0
44.5 × 24.5 × 2.0 R付	100 × 50 × 2.5
	100 × 50 × 3.0

押出 角棒

受注生産

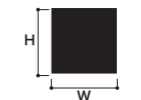

9
